



ALULINE A100 UM

Exit luminaire in compliance with EN 60598-1/2-22 and EN 1838.

Elegant and modern design, made of aluminum in white or black, special colors possible.

By simply remounting the container, the luminaire can be used universally for ceiling and wall mounting. A 90 degree parallel wall mounting is also possible, a corresponding pictogram set is optionally available.

With the two accessory sets, central pendulum and wire mounting, the luminaire is very changeable and versatile.

The 10 mm light-deflecting pane is illuminated with a 1 or 2 watt LED-bar.

The luminaire price includes one pictogram foil set - arrow left/right/down/up/blind (Visibility distance 10 m).



Technical specifications

Luminaire type	Luminaires for central battery systems		Self contained luminaires	
	1 W LED-bar	2 W LED-bar	1 W LED-bar	2 W LED-bar
Illuminant				
Visibility distance	10 m			
Connecting terminals	2 x 2.5 mm ² for double assignment			
Colour	white / black			
Material	Aluminum die-cast			
Mounting type	Wall-/ceiling mounting			
Dimensions (W x H x D)	DM 191 x 126 x 83 mm WM 191 x 96 x 53 mm			
Pane dimensions (W x H x D)	185 x 80.5 x 10 mm			
Protection class	IP40			
Safety class	II			
IK Safety class	IK03			
Light current (mains)	130 lm	260 lm	130 lm	260 lm
Luminous flux Emergency (DC) / mains				
Rated operating time 1h	-	-	50% / 100%	30% / 100%
Rated operating time 3h	-	-	50% / 100%	30% / 100%
Rated operating time 8h	-	-	25% / 100%	15% / 100%
Power consumption	4.5 VA	5.5 VA	4.5 VA	5.5 VA
Battery current input	11 mA	14 mA	-	
Battery duration	-		1h / 3h / 8h	
Battery operation				
Voltage supply	230V 50/60Hz; 220V DC +25/-20%		230V 50/60Hz	
NiMH-battery				
Rated operating time 1h	-	-	4,8V 0,8Ah	4,8V 0,8Ah
Rated operating time 3h	-	-	4,8V 0,8Ah	4,8V 0,8Ah
Rated operating time 8h	-	-	4,8V 0,8Ah	4,8V 0,8Ah
Temperature range	-10°C to +40°C		-	
Non-maintained mode	-		0°C to +35°C	
Maintained mode	-		-5°C to +30°C	
optional				
Multi-switch and monitoring module	ELC MSÜ3 SET009 SET010		-	
Self monitoring	-		SELF CHECK	
Central monitoring	-		SAFELOG Line	
Wireless monitoring	-		SAFELOG Wireless	

Ceiling mounting

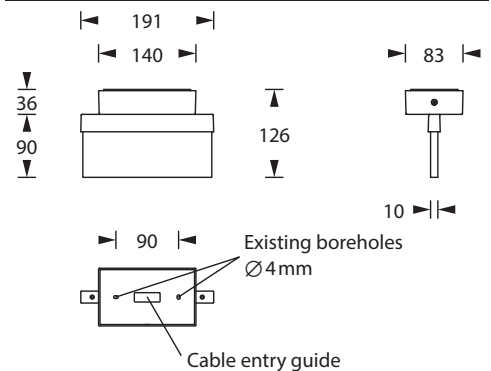

Wall mounting

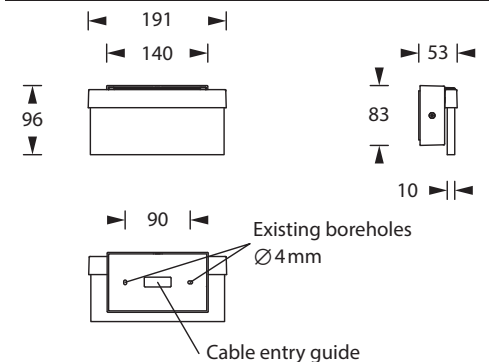

Pictogram-set - included in the delivery



Optional pictograms (-sets)

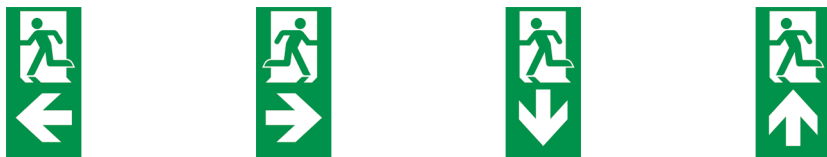

Accessories

Universal cover plate

Back Box ALULINE

Central pendulum - ALULINE

Cable assembly set ALULINE - conducting

Pictograms