



# SMARTLUX 200 TWIN DM

## Multi-purpose luminaire in compliance with EN 60598-1/2-22 and EN 1838.

Combined escape sign and emergency luminaire made of white polycarbonate with clear cover and simple, screwless mounting by click system. Luminaire for one-sided mounting of pictograms for ceiling mounting and simultaneous illumination of areas or escape routes. The optics for area illumination are already pre-mounted, those for escape routes are enclosed. The luminaire price includes one plug-in pictogram foil set - arrow left/right/down/up/blind (Visibility distance 23 m) per luminaire. The luminaire is equipped with a 2 Watt LED-bar and additionally with a 3 Watt Power LED. Despite the combination of two types of luminaires, this luminaire is only a single luminaire. Therefore, it is also counted as only one luminaire in the circuit.



## Technical specifications

Luminaire type	Luminaires for central battery systems	Self contained luminaires
Illuminant	2 W LED-bar	2 W LED-bar
Illuminant safety modul	3W LED	3W LED
Visibility distance	23 m	
Connecting terminals	2 x 2.5 mm <sup>2</sup> for double assignment	
Colour	white	
Material	Polycarbonate (light cover clear)	
Mounting type	Ceiling mounting	
Additional mounting types*	wall bracket mounting, Ceiling mounting (wire suspension), Pendulum mounting	
Dimensions (W x H x D)	DM 243 x 152 x 62 mm	
Protection class	IP43	
Safety class	II	
IK Safety class	IK03	
Light current (mains)	240 lm	240 lm
Luminous flux Emergency (DC) / mains		
Rated operating time 1h	-	30% / 100%
Rated operating time 3h	-	30% / 100%
Light (Net) current safety module	190 lm	-
Light current (Emergency) safety module		
Rated operating time 1h	-	190 lm
Rated operating time 3h	-	190 lm
Luminous flux Emergency (DC) / mains safety module		
Rated operating time 1h	-	100% / 0%
Rated operating time 3h	-	100% / 0%
Power consumption	11.5 VA	10.5 VA
Battery current input	29 mA	-
Battery duration		
Battery operation	-	1h / 3h
Voltage supply	230V 50/60Hz; 220V DC +25/-20%	230V 50/60Hz
NiMH-battery		
Rated operating time 1h	-	4,8V 2,0Ah
Rated operating time 3h	-	4,8V 2,0Ah
Temperature range	-10°C to +40°C	-
Non-maintained mode	-	0°C to +35°C
Maintained mode	-	-5°C to +30°C
Circuit options		
Pictogram	maintained mode DS maintained mode DS (no monitoring), DS / BS switchable (with monitoring module)	DS / BS switchable
Safety modul		non-maintained mode BS

## Ceiling mounting

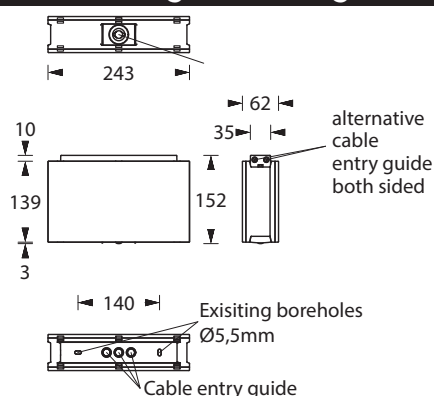

optional		
Multi-switch and monitoring module	ELC MSÜ3 SET009 SET010	-
Self monitoring	-	SELF CHECK
Central monitoring	-	SAFELOG Line
Wireless monitoring	-	SAFELOG Wireless

\* Optional accessory required

### Pictogram-set - included in the delivery



### Optional pictograms (-sets)



### Accessories

Universal cover plate

Chain assembly set

Central pendulum - Plastic

Cable assembly set

Wall bracket

Pictograms

### Lighting data and tables of luminaire distances (E = 1.25 lx)

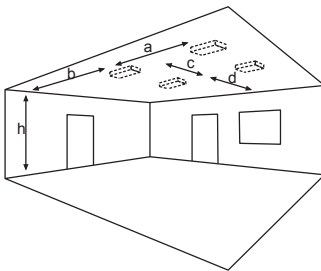

Ceiling mounting

#### Luminaires for central battery systems wide area optics

Distance table for plane emergency routes / distance data in meters

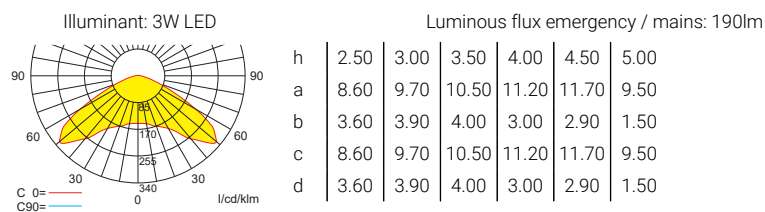

#### Self contained luminaires wide area optics

Distance table for plane emergency routes / distance data in meters

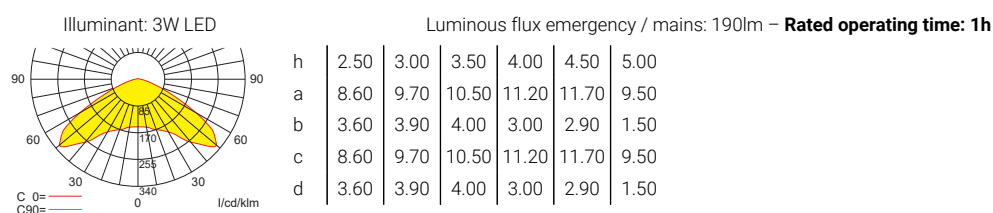

**Self contained luminaires wide area optics**

**Distance table for plane emergency routes / distance data in meters**

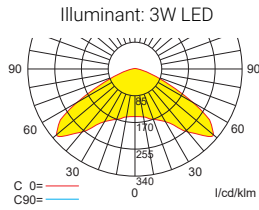

Luminous flux emergency / mains: 190lm – **Rated operating time: 3h**

h	2.50	3.00	3.50	4.00	4.50	5.00
a	8.60	9.70	10.50	11.20	11.70	9.50
b	3.60	3.90	4.00	3.00	2.90	1.50
c	8.60	9.70	10.50	11.20	11.70	9.50
d	3.60	3.90	4.00	3.00	2.90	1.50

**Luminaires for central battery systems escape route optics**

**Distance table for plane emergency routes / distance data in meters**

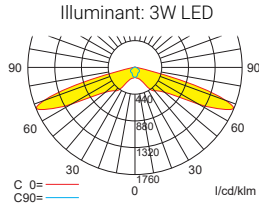

Luminous flux emergency / mains: 190lm

h	2.50	3.00	3.50	4.00	4.50	5.00	5.50	6.00
a	-	-	-	-	-	-	-	-
b	-	-	-	-	-	-	-	-
c	16.20	18.20	20.10	22.00	23.70	24.30	15.60	13.60
d	7.00	8.10	8.70	9.00	8.80	8.20	5.60	5.40

**Self contained luminaires escape route optics**

**Distance table for plane emergency routes / distance data in meters**

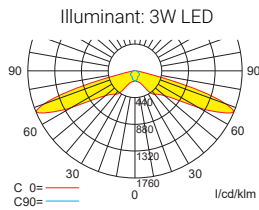

Luminous flux emergency / mains: 190lm – **Rated operating time: 1h**

h	2.50	3.00	3.50	4.00	4.50	5.00	5.50	6.00
a	-	-	-	-	-	-	-	-
b	-	-	-	-	-	-	-	-
c	16.20	18.20	20.10	22.00	23.70	24.30	15.60	13.60
d	7.00	8.10	8.70	9.00	8.80	8.20	5.60	5.40

**Self contained luminaires escape route optics**

**Distance table for plane emergency routes / distance data in meters**

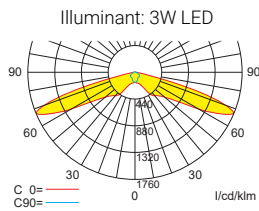

Luminous flux emergency / mains: 190lm – **Rated operating time: 3h**

h	2.50	3.00	3.50	4.00	4.50	5.00	5.50	6.00
a	-	-	-	-	-	-	-	-
b	-	-	-	-	-	-	-	-
c	16.20	18.20	20.10	22.00	23.70	24.30	15.60	13.60
d	7.00	8.10	8.70	9.00	8.80	8.20	5.60	5.40