



SMARTLUX 300 BEL WM/DM

Safety luminaire in compliance with EN 60598-1/2-22 and EN 1838.

Appealing, modern IP54 safety luminaire for wide area illumination, made of white polycarbonate and clear cover. Easy to install due to screwless click system.

The central battery version is available with 1,5 Watt, 3 Watt, 6 Watt or 10 Watt LED-bar. The self-contained luminaire is equipped with either 1,5 Watt or 3 Watt LED-bar.



Technical specifications

Luminaire type	Luminaires for central battery systems				Self contained luminaires	
	1.5 W LED-bar	3 W LED-bar	6 W LED-bar	10 W LED-bar	1.5 W LED-bar	3 W LED-bar
Illuminant						
Connecting terminals	2 x 2.5 mm ² for double assignment					
Colour	white					
Material	Polycarbonate (light cover clear)					
Mounting type	Wall-/ceiling mounting					
Additional mounting types*	Recessed mounting, Ceiling mounting (wire suspension), Wall recessed mounting, Pendulum mounting					
Dimensions (W x H x D)	WM/DM 313 x 174 x 54 mm					
Protection class	IP54					
Safety class	II					
IK Safety class	IK03					
Light current (mains)	190 lm	350 lm	600 lm	1050 lm	190 lm	350 lm
Light current (emergency)						
Rated operating time 1h	-	-	-	-	190 lm	350 lm
Rated operating time 3h	-	-	-	-	190 lm	350 lm
Rated operating time 8h	-	-	-	-	190 lm	-
Luminous flux						
Emergency (DC) / mains						
Rated operating time 1h	-	-	-	-	100% / 100%	100% / 100%
Rated operating time 3h	-	-	-	-	100% / 100%	100% / 100%
Rated operating time 8h	-	-	-	-	100% / 100%	-
Power consumption	5 VA	6 VA	10.3 VA	15 VA	5 VA	6 VA
Battery current input	12 mA	19 mA	27 mA	41 mA	-	-
Battery duration						
Battery operation						1h / 3h / 8h
Voltage supply	230V 50/60Hz; 220V DC +25/-20%				230V 50/60Hz	
NiMH-battery						
Rated operating time 1h	-	-	-	-	4,8V 2,0Ah	4,8V 2,0Ah
Rated operating time 3h	-	-	-	-	4,8V 2,0Ah	4,8V 4,2Ah
Rated operating time 8h	-	-	-	-	4,8V 4,2Ah	-
Temperature range	-10°C to +40°C					
Non-maintained mode	-					
Maintained mode	-					
optional						
Multi-switch and monitoring module	DALI ELC MSÜ3 SET009 SET010				-	
Self monitoring	-				SELF CHECK	
Central monitoring	-				SAFELOG Line	
Wireless monitoring	-				SAFELOG Wireless	

* Optional accessory required

Accessories

Ball protection cover
Wire guard
Recessed frame - set
Universal cover plate
Central pendulum - Plastic
Cable assembly set

Wall-/ceiling mounting

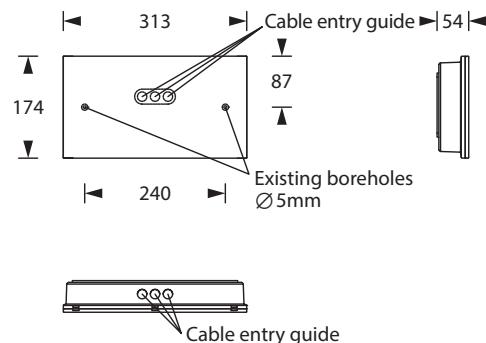

Lighting data and tables of luminaire distances (E = 1,25 lx)

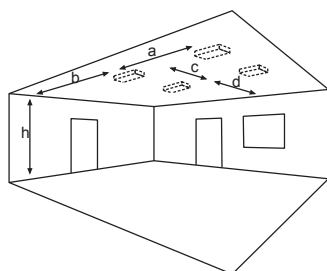

Ceiling mounting

Luminaires for central battery systems Wide area illumination

Distance table for plane emergency routes / distance data in meters

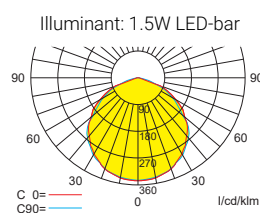

Luminous flux emergency / mains: 190lm

h	2.50	3.00	3.50	4.00	4.50	5.00	5.50	6.00	6.50	7.00	7.50	8.00
a	8.00	8.60	9.00	9.40	9.80	10.00	10.10	10.00	9.00	9.40	8.90	6.90
b	3.20	3.40	3.60	3.60	3.50	3.40	3.20	2.80	2.40	1.80	1.10	1.00
c	8.20	8.80	9.30	9.50	9.80	9.90	9.90	9.80	9.50	9.20	8.80	7.00
d	3.30	3.40	3.50	3.50	3.40	3.30	3.10	2.80	2.40	1.90	1.00	0.90

Luminaires for central battery systems Wide area illumination

Distance table for plane emergency routes / distance data in meters

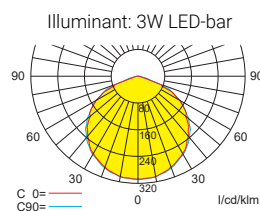

Luminous flux emergency / mains: 350lm

h	2.50	3.00	3.50	4.00	4.50	5.00	5.50	6.00	6.50	7.00	7.50	8.00	8.50	9.00	9.50	10.00	10.50	11.00
a	9.40	10.30	11.20	11.80	11.90	12.30	12.60	12.80	13.00	13.00	13.00	12.50	12.30	12.10	11.40	11.00	9.00	7.80
b	4.00	4.10	4.30	4.40	4.50	4.50	4.40	4.30	4.20	4.00	3.60	3.20	2.50	1.50	1.50	0.80	0.70	0.60
c	9.80	10.30	11.20	11.40	11.90	12.30	12.20	12.80	13.00	12.60	12.50	12.50	12.30	12.10	11.40	11.00	9.00	7.80
d	4.00	4.20	4.30	4.40	4.50	4.50	4.40	4.30	4.20	3.80	3.40	3.00	2.50	1.50	1.50	0.80	0.70	0.60

Luminaires for central battery systems Wide area illumination

Distance table for plane emergency routes / distance data in meters

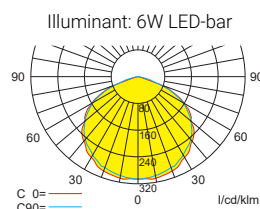

Luminous flux emergency / mains: 600lm

h	2.00	3.00	4.00	5.00	6.00	7.00	8.00	9.00	10.00	11.00	12.00	13.00	14.00
a	9.90	12.40	14.10	15.30	16.10	16.80	16.80	16.90	16.60	16.00	15.20	14.10	10.00
b	4.20	5.10	5.60	5.90	6.00	5.90	5.50	5.00	4.20	2.80	2.10	1.50	1.00
c	10.20	12.60	14.30	15.50	16.30	16.60	17.20	17.30	16.90	16.30	15.60	14.10	10.00
d	4.30	5.10	5.70	5.90	6.10	6.00	5.70	5.20	4.50	3.20	2.80	1.50	1.00

Luminaires for central battery systems Wide area illumination

Distance table for plane emergency routes / distance data in meters

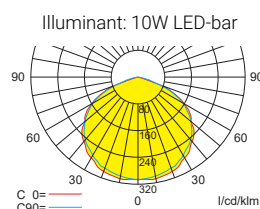

Luminous flux emergency / mains: 1050lm

h	2.00	3.00	4.00	5.00	6.00	7.00	8.00	9.00	10.00	11.00	12.00	13.00	14.00	15.00	16.00	17.00	18.00	19.00
a	10.20	14.20	16.40	18.20	19.50	20.60	21.20	21.90	22.10	22.30	22.20	21.90	21.30	20.50	19.50	18.40	15.40	13.00
b	4.40	5.90	6.70	7.30	7.60	7.80	7.90	7.70	7.50	7.00	6.50	5.70	4.40	2.40	2.90	2.00	1.80	1.00
c	10.50	14.20	16.60	18.40	19.70	20.90	21.50	21.80	22.30	22.70	22.60	22.30	21.70	21.20	20.30	18.90	15.80	13.00
d	4.40	6.00	6.80	7.40	7.70	7.80	8.00	7.90	7.60	7.30	6.70	6.00	4.90	2.90	2.90	2.00	2.00	1.00

Self contained luminaires Wide area illumination

Distance table for plane emergency routes / distance data in meters

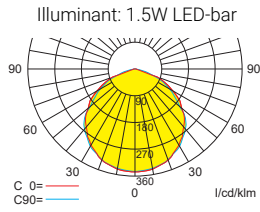

Luminous flux emergency / mains: 190lm/190lm – **Rated operating time: 1h**

h	2.50	3.00	3.50	4.00	4.50	5.00	5.50	6.00	6.50	7.00	7.50	8.00
a	8.00	8.60	9.00	9.40	9.80	10.00	10.10	10.00	9.00	9.40	8.90	6.90
b	3.20	3.40	3.60	3.60	3.50	3.40	3.20	2.80	2.40	1.80	1.10	1.00
c	8.20	8.80	9.30	9.50	9.80	9.90	9.90	9.80	9.50	9.20	8.80	7.00
d	3.30	3.40	3.50	3.50	3.40	3.30	3.10	2.80	2.40	1.90	1.00	0.90

Self contained luminaires Wide area illumination

Distance table for plane emergency routes / distance data in meters

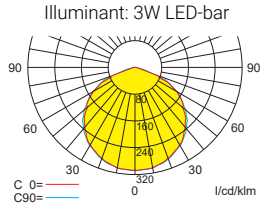

Luminous flux emergency / mains: 350lm/350lm – **Rated operating time: 1h**

h	2.50	3.00	3.50	4.00	4.50	5.00	5.50	6.00	6.50	7.00	7.50	8.00	8.50	9.00	9.50	10.00	10.50	11.00
a	9.40	10.30	11.20	11.80	11.90	12.30	12.60	12.80	13.00	13.00	13.00	12.50	12.30	12.10	11.40	11.00	9.00	7.80
b	4.00	4.10	4.30	4.40	4.50	4.50	4.40	4.30	4.20	4.00	3.60	3.20	2.50	1.50	1.50	0.80	0.70	0.60
c	9.80	10.30	11.20	11.40	11.90	12.30	12.20	12.80	13.00	12.60	12.50	12.50	12.30	12.10	11.40	11.00	9.00	7.80
d	4.00	4.20	4.30	4.40	4.50	4.50	4.40	4.30	4.20	3.80	3.40	3.00	2.50	1.50	1.50	0.80	0.70	0.60

Self contained luminaires Wide area illumination

Distance table for plane emergency routes / distance data in meters

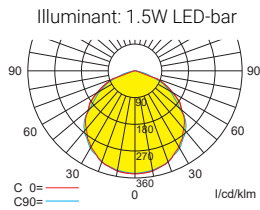

Luminous flux emergency / mains: 190lm/190lm – **Rated operating time: 3h**

h	2.50	3.00	3.50	4.00	4.50	5.00	5.50	6.00	6.50	7.00	7.50	8.00
a	8.00	8.60	9.00	9.40	9.80	10.00	10.10	10.00	9.00	9.40	8.90	6.90
b	3.20	3.40	3.60	3.60	3.50	3.40	3.20	2.80	2.40	1.80	1.10	1.00
c	8.20	8.80	9.30	9.50	9.80	9.90	9.90	9.80	9.50	9.20	8.80	7.00
d	3.30	3.40	3.50	3.50	3.40	3.30	3.10	2.80	2.40	1.90	1.00	0.90

Self contained luminaires Wide area illumination

Distance table for plane emergency routes / distance data in meters

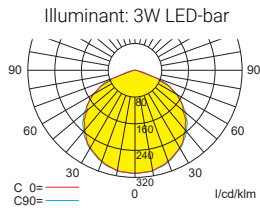

Luminous flux emergency / mains: 350lm/350lm – **Rated operating time: 3h**

h	2.50	3.00	3.50	4.00	4.50	5.00	5.50	6.00	6.50	7.00	7.50	8.00	8.50	9.00	9.50	10.00	10.50	11.00
a	9.40	10.30	11.20	11.80	11.90	12.30	12.60	12.80	13.00	13.00	13.00	12.50	12.30	12.10	11.40	11.00	9.00	7.80
b	4.00	4.10	4.30	4.40	4.50	4.50	4.40	4.30	4.20	4.00	3.60	3.20	2.50	1.50	1.50	0.80	0.70	0.60
c	9.80	10.30	11.20	11.40	11.90	12.30	12.20	12.80	13.00	12.60	12.50	12.50	12.30	12.10	11.40	11.00	9.00	7.80
d	4.00	4.20	4.30	4.40	4.50	4.50	4.40	4.30	4.20	3.80	3.40	3.00	2.50	1.50	1.50	0.80	0.70	0.60

Self contained luminaires Wide area illumination

Distance table for plane emergency routes / distance data in meters

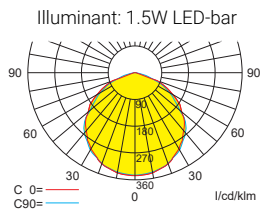

Luminous flux emergency / mains: 190lm/190lm – **Rated operating time: 8h**

h	2.50	3.00	3.50	4.00	4.50	5.00	5.50	6.00	6.50	7.00	7.50	8.00
a	8.00	8.60	9.00	9.40	9.80	10.00	10.10	10.00	9.00	9.40	8.90	6.90
b	3.20	3.40	3.60	3.60	3.50	3.40	3.20	2.80	2.40	1.80	1.10	1.00
c	8.20	8.80	9.30	9.50	9.80	9.90	9.90	9.80	9.50	9.20	8.80	7.00
d	3.30	3.40	3.50	3.50	3.40	3.30	3.10	2.80	2.40	1.90	1.00	0.90