



# SBOX V2A 300 BEL-T DM

## Safety luminaire in compliance with EN 60598-1/2-22 and EN 1838.

Very robust safety luminaire made of brushed stainless steel (V2A) for ceiling mounting and equipped with hall downlight optics for high ceilings. The luminaire is equipped with an IP65 membrane pressure compensation valve and a pane of 8 mm toughened safety glass as standard.

The luminaire is available as a system luminaire for central battery systems with either a 3 watt, 6 watt or 10 watt LED-bar and as a single-battery version with a 3 watt or 6 watt LED-bar.



## Technical specifications

Luminaire type	Luminaires for central battery systems			Self contained luminaires	
	3 W LED-bar	6 W LED-bar	10 W LED-bar	3 W LED-bar	6 W LED-bar
Connecting terminals	3 x 2.5 mm <sup>2</sup> for double assignment				
Colour	Stainless steel brushed				
Material	Stainless steel (V2A)				
Mounting type	Ceiling mounting				
Dimensions (W x H x D)	DM 384 x 234 x 101 mm				
Protection class	IP65				
Safety class	I				
IK Safety class	IK10				
Light current (mains)	350 lm	600 lm	1050 lm	350 lm	580 lm
Light current (emergency)					
Rated operating time 1h	-	-	-	350 lm	580 lm
Rated operating time 3h	-	-	-	350 lm	580 lm
Rated operating time 8h	-	-	-	320 lm	320 lm
Luminous flux Emergency (DC) / mains					
Rated operating time 1h	-	-	-	100% / 100%	100% / 100%
Rated operating time 3h	-	-	-	100% / 100%	100% / 100%
Rated operating time 8h	-	-	-	90% / 100%	55% / 100%
Power consumption	6 VA	10.3 VA	15 VA	9.5 VA	11.5 VA
Battery current input	19 mA	27 mA	41 mA	-	
Battery duration Battery operation		-		1h / 3h / 8h	
Voltage supply	230V 50/60Hz; 220V DC +25/-20%			230V 50/60Hz	
NiMH-battery					
Rated operating time 1h	-	-	-	4,8V 2,0Ah	4,8V 2,0Ah
Rated operating time 3h	-	-	-	4,8V 2,0Ah	4,8V 4,2Ah
Rated operating time 8h	-	-	-	4,8V 4,2Ah	4,8V 4,2Ah
Temperature range	-10°C to +40°C			-	
Non-maintained mode	-			0°C to +35°C	
Maintained mode	-			-5°C to +30°C	
optional					
Multi-switch and monitoring module	DALI ELC MSÜ3 SET009 SET010			-	
Self monitoring	-			SELF CHECK	
Central monitoring	-			SAFELOG Line	
Wireless monitoring	-			SAFELOG Wireless	

# Ceiling mounting

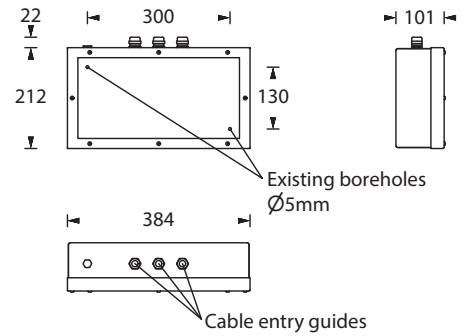

## Lighting data and tables of luminaire distances ( $E = 1,25\text{ lx}$ )

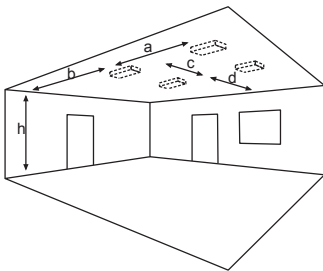

Ceiling mounting

### Luminaires for central battery systems **downlight optics**

Distance table for plane emergency routes / distance data in meters

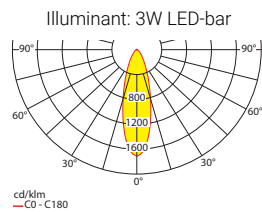

Luminous flux emergency / mains: 350lm

h	7.00	8.00	9.00	10.00	11.00	12.00	13.00	14.00	15.00	16.00	17.00	18.00	19.00	20.00	21.00
a	9.90	10.40	10.80	11.10	11.30	11.50	11.70	11.80	11.90	11.90	11.80	11.70	11.60	11.40	11.10
b	3.90	4.00	4.10	4.20	4.20	4.20	4.10	4.00	3.90	3.70	3.50	3.30	2.90	2.40	1.70
c	9.90	10.40	10.80	11.10	11.30	11.50	11.70	11.80	11.90	11.90	11.80	11.70	11.60	11.40	11.10
d	3.90	4.00	4.10	4.20	4.20	4.20	4.10	4.00	3.90	3.70	3.50	3.30	2.90	2.40	1.70

### Luminaires for central battery systems **downlight optics**

Distance table for plane emergency routes / distance data in meters

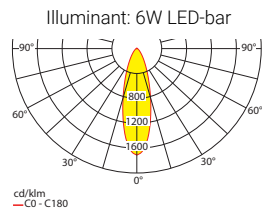

Luminous flux emergency / mains: 600lm

h	7.00	8.00	9.00	10.00	11.00	12.00	13.00	14.00	15.00	16.00	17.00	18.00	19.00	20.00	21.00	22.00	23.00	28.00
a	11.70	12.30	12.90	13.40	13.80	14.20	14.50	14.70	15.00	15.20	15.30	15.40	15.50	15.60	15.50	15.50	15.40	14.40
b	4.70	4.90	5.10	5.20	5.30	5.40	5.50	5.50	5.50	5.50	5.40	5.30	5.20	5.10	4.90	4.70	4.40	1.60
c	11.70	12.30	12.90	13.40	13.80	14.20	14.50	14.70	15.00	15.20	15.30	15.40	15.50	15.60	15.50	15.50	15.40	14.40
d	4.70	4.90	5.10	5.20	5.30	5.40	5.50	5.50	5.50	5.50	5.40	5.30	5.20	5.10	4.90	4.70	4.40	1.60

### Luminaires for central battery systems **downlight optics**

Distance table for plane emergency routes / distance data in meters

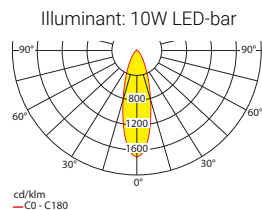

Luminous flux emergency / mains: 1050lm

h	7.00	9.00	11.00	13.00	15.00	17.00	19.00	21.00	23.00	25.00	27.00	29.00	31.00	33.00	35.00	37.00
a	13.80	15.30	16.50	17.60	18.40	19.10	19.60	20.00	20.30	20.50	20.60	20.50	20.30	20.00	19.60	19.10
b	5.60	6.20	6.60	6.90	7.10	7.20	7.30	7.20	7.10	6.90	6.60	6.20	5.70	5.00	4.00	2.20
c	13.80	15.30	16.50	17.60	18.40	19.10	19.60	20.00	20.30	20.50	20.60	20.50	20.30	20.00	19.60	19.10
d	5.60	6.20	6.60	6.90	7.10	7.20	7.30	7.20	7.10	6.90	6.60	6.20	5.70	5.00	4.00	2.20

### Self contained luminaires **downlight optics**

Distance table for plane emergency routes / distance data in meters

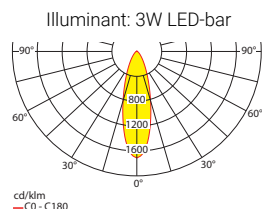

Luminous flux emergency / mains: 350lm/350lm – **Rated operating time: 1h**

h	7.00	8.00	9.00	10.00	11.00	12.00	13.00	14.00	15.00	16.00	17.00	18.00	19.00	20.00	21.00
a	9.90	10.40	10.80	11.10	11.30	11.50	11.70	11.80	11.90	11.90	11.80	11.70	11.60	11.40	11.10
b	3.90	4.00	4.10	4.20	4.20	4.20	4.10	4.00	3.90	3.70	3.50	3.30	2.90	2.40	1.70
c	9.90	10.40	10.80	11.10	11.30	11.50	11.70	11.80	11.90	11.90	11.80	11.70	11.60	11.40	11.10
d	3.90	4.00	4.10	4.20	4.20	4.20	4.10	4.00	3.90	3.70	3.50	3.30	2.90	2.40	1.70

**Self contained luminaires downlight optics**

**Distance table for plane emergency routes / distance data in meters**

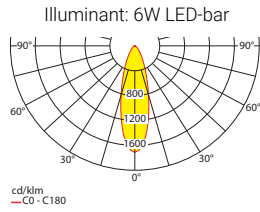

Luminous flux emergency / mains: 580lm/580lm – **Rated operating time: 1h**

h	7.00	8.00	9.00	10.00	11.00	12.00	13.00	14.00	15.00	16.00	17.00	18.00	19.00	20.00	21.00	27.00
a	11.60	12.20	12.70	13.20	13.60	14.00	14.30	14.50	14.80	14.90	15.10	15.20	15.30	15.30	15.20	14.30
b	4.70	4.90	5.00	5.20	5.30	5.30	5.40	5.40	5.40	5.40	5.30	5.20	5.10	4.90	4.70	2.20
c	11.60	12.20	12.70	13.20	13.60	14.00	14.30	14.50	14.80	14.90	15.10	15.20	15.30	15.30	15.20	14.30
d	4.70	4.90	5.00	5.20	5.30	5.30	5.40	5.40	5.40	5.40	5.30	5.20	5.10	4.90	4.70	2.20

**Self contained luminaires downlight optics**

**Distance table for plane emergency routes / distance data in meters**

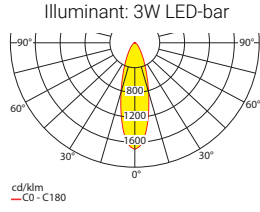

Luminous flux emergency / mains: 350lm/350lm – **Rated operating time: 3h**

h	7.00	8.00	9.00	10.00	11.00	12.00	13.00	14.00	15.00	16.00	17.00	18.00	19.00	20.00	21.00
a	9.90	10.40	10.80	11.10	11.30	11.50	11.70	11.80	11.90	11.90	11.80	11.70	11.60	11.40	11.10
b	3.90	4.00	4.10	4.20	4.20	4.20	4.10	4.00	3.90	3.70	3.50	3.30	2.90	2.40	1.70
c	9.90	10.40	10.80	11.10	11.30	11.50	11.70	11.80	11.90	11.90	11.80	11.70	11.60	11.40	11.10
d	3.90	4.00	4.10	4.20	4.20	4.20	4.10	4.00	3.90	3.70	3.50	3.30	2.90	2.40	1.70

**Self contained luminaires downlight optics**

**Distance table for plane emergency routes / distance data in meters**

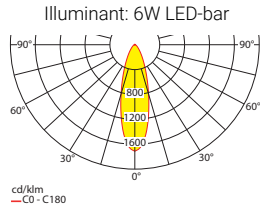

Luminous flux emergency / mains: 580lm/580lm – **Rated operating time: 3h**

h	7.00	8.00	9.00	10.00	11.00	12.00	13.00	14.00	15.00	16.00	17.00	18.00	19.00	20.00	21.00	27.00
a	11.60	12.20	12.70	13.20	13.60	14.00	14.30	14.50	14.80	14.90	15.10	15.20	15.30	15.30	15.20	14.30
b	4.70	4.90	5.00	5.20	5.30	5.30	5.40	5.40	5.40	5.40	5.30	5.20	5.10	4.90	4.70	2.20
c	11.60	12.20	12.70	13.20	13.60	14.00	14.30	14.50	14.80	14.90	15.10	15.20	15.30	15.30	15.20	14.30
d	4.70	4.90	5.00	5.20	5.30	5.30	5.40	5.40	5.40	5.40	5.30	5.20	5.10	4.90	4.70	2.20

**Self contained luminaires downlight optics**

**Distance table for plane emergency routes / distance data in meters**

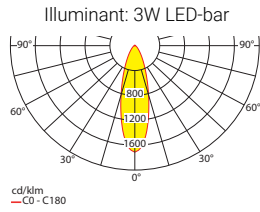

Luminous flux emergency / mains: 320lm/350lm – **Rated operating time: 8h**

h	7.00	8.00	9.00	10.00	11.00	12.00	13.00	14.00	15.00	16.00	17.00	18.00	19.00	20.00
a	9.60	10.10	10.40	10.70	11.00	11.10	11.30	11.30	11.40	11.30	11.20	11.10	10.90	10.60
b	3.80	3.90	4.00	4.00	4.00	4.00	3.90	3.80	3.60	3.40	3.20	2.80	2.40	1.70
c	9.60	10.10	10.40	10.70	11.00	11.10	11.30	11.30	11.40	11.30	11.20	11.10	10.90	10.60
d	3.80	3.90	4.00	4.00	4.00	4.00	3.90	3.80	3.60	3.40	3.20	2.80	2.40	1.70

**Self contained luminaires downlight optics**

**Distance table for plane emergency routes / distance data in meters**

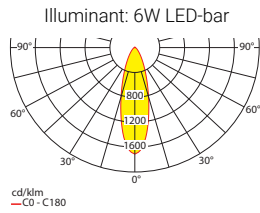

Luminous flux emergency / mains: 320lm/580lm – **Rated operating time: 8h**

h	7.00	8.00	9.00	10.00	11.00	12.00	13.00	14.00	15.00	16.00	17.00	18.00	19.00	20.00
a	9.60	10.10	10.40	10.70	11.00	11.10	11.30	11.30	11.40	11.30	11.20	11.10	10.90	10.60
b	3.80	3.90	4.00	4.00	4.00	4.00	3.90	3.80	3.60	3.40	3.20	2.80	2.40	1.70
c	9.60	10.10	10.40	10.70	11.00	11.10	11.30	11.30	11.40	11.30	11.20	11.10	10.90	10.60
d	3.80	3.90	4.00	4.00	4.00	4.00	3.90	3.80	3.60	3.40	3.20	2.80	2.40	1.70