



L-PLAST 200 UM-BEL

Multi-purpose luminaire in compliance with EN 60598-1/2-22 and EN 1838.

Polycarbonate housing with clear luminaire cover for one or two-sided pictogram attachment with high cover for wall or ceiling mounting.

The luminaire price includes one pictogram foil set per luminaire - arrow left/right/down/up (Visibility distance 18 m).

The luminaire is supplied with a 3 Watt LED-bar.



Technical specifications

Luminaire type	Luminaires for central battery systems	Self contained luminaires
Illuminant	3 W LED-bar	3 W LED-bar
Visibility distance	18 m	
Connecting terminals	2 x 2.5 mm ² for double assignment	
Colour	white	
Material	Polycarbonate (light cover clear)	
Mounting type	Wall-/ceiling mounting	
Additional mounting types*	wall bracket mounting, Ceiling mounting (wire suspension), Pendulum mounting	
Dimensions (W x H x D)	WM/DM 372 x 132 x 94 mm	
Protection class	IP54	
Safety class	II	
IK Safety class	IK03	
Light current (mains)	380 lm	380 lm
Light current (emergency)		
Rated operating time 1h	-	380 lm
Rated operating time 3h	-	380 lm
Rated operating time 8h	-	190 lm
Luminous flux		
Emergency (DC) / mains		
Rated operating time 1h	-	100% / 100%
Rated operating time 3h	-	100% / 100%
Rated operating time 8h	-	50% / 100%
Power consumption	6 VA	6 VA
Battery current input	19 mA	-
Battery duration	-	1h / 3h / 8h
Battery operation		
Voltage supply	230V 50/60Hz; 220V DC +25/-20%	230V 50/60Hz
NiMH-battery		
Rated operating time 1h	-	4,8V 2,0Ah
Rated operating time 3h	-	4,8V 4,2Ah
Rated operating time 8h	-	4,8V 4,2Ah
Temperature range	-10°C to +40°C	-
Non-maintained mode	-	0°C to +35°C
Maintained mode	-	-5°C to +30°C
optional		
Multi-switch and monitoring module	DALI ELC MSÜ3 SET009 SET010	-
Self monitoring	-	SELF CHECK
Central monitoring	-	SAFELOG Line
Wireless monitoring	-	SAFELOG Wireless

* Optional accessory required

Wall-/ceiling mounting

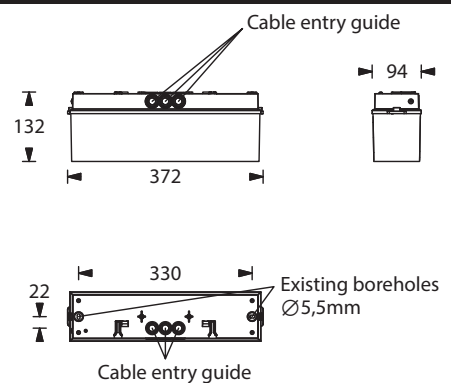

Pictogram-set - included in the delivery



Accessories

- Wire guard
- Universal cover plate
- Chain assembly set
- Double pendulum set with long canopy
- Central pendulum sets with long canopy
- Central pendulum - Plastic
- Wire sets with long canopy
- Cable assembly set
- Wall bracket
- Set for parallel wall mounting

Lighting data and tables of luminaire distances (E = 1,25 lx)

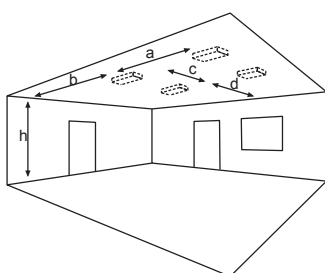

Ceiling mounting

Luminaires for central battery systems Wide area illumination

Distance table for plane emergency routes / distance data in meters

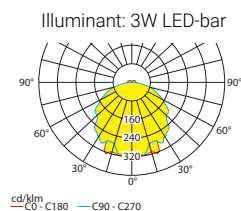

Luminous flux emergency / mains: 380lm

h	2.00	2.50	3.00	3.50	4.00	4.50	5.00	5.50	6.00	6.50	7.00	7.50	8.00	8.50	9.00	9.50
a	9.70	10.60	11.40	12.10	12.50	13.10	13.50	13.70	13.60	13.40	13.40	13.50	13.80	13.60	13.50	12.90
b	3.90	4.30	4.50	4.80	4.80	4.80	4.80	4.80	4.90	4.70	4.50	4.20	3.90	2.60	2.20	1.80
c	6.70	7.40	8.00	8.30	8.30	8.00	7.60	7.20	7.20	7.40	7.60	7.80	8.00	8.20	8.40	8.70
d	2.70	2.90	2.90	2.70	2.50	2.60	2.70	2.80	2.90	3.00	3.20	3.30	3.40	3.60	3.40	2.00

Self contained luminaires Wide area illumination

Distance table for plane emergency routes / distance data in meters

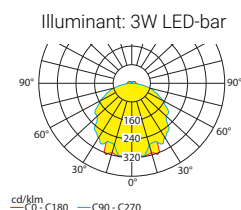

Luminous flux emergency / mains: 380lm/380lm – Rated operating time: 1h

h	2.00	2.50	3.00	3.50	4.00	4.50	5.00	5.50	6.00	6.50	7.00	7.50	8.00	8.50	9.00	9.50
a	9.70	10.60	11.40	12.10	12.50	13.10	13.50	13.70	13.60	13.40	13.40	13.50	13.80	13.60	13.50	12.90
b	3.90	4.30	4.50	4.80	4.80	4.80	4.80	4.80	4.90	4.70	4.50	4.20	3.90	2.60	2.20	1.80
c	6.70	7.40	8.00	8.30	8.30	8.00	7.60	7.20	7.20	7.40	7.60	7.80	8.00	8.20	8.40	8.70
d	2.70	2.90	2.90	2.70	2.50	2.60	2.70	2.80	2.90	3.00	3.20	3.30	3.40	3.60	3.40	2.00

Self contained luminaires Wide area illumination

Distance table for plane emergency routes / distance data in meters

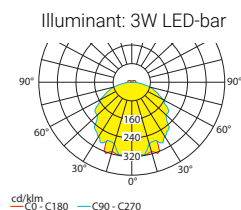

Luminous flux emergency / mains: 380lm/380lm – Rated operating time: 3h

h	2.00	2.50	3.00	3.50	4.00	4.50	5.00	5.50	6.00	6.50	7.00	7.50	8.00	8.50	9.00	9.50
a	9.70	10.60	11.40	12.10	12.50	13.10	13.50	13.70	13.60	13.40	13.40	13.50	13.80	13.60	13.50	12.90
b	3.90	4.30	4.50	4.80	4.80	4.80	4.80	4.80	4.90	4.70	4.50	4.20	3.90	2.60	2.20	1.80
c	6.70	7.40	8.00	8.30	8.30	8.00	7.60	7.20	7.20	7.40	7.60	7.80	8.00	8.20	8.40	8.70
d	2.70	2.90	2.90	2.70	2.50	2.60	2.70	2.80	2.90	3.00	3.20	3.30	3.40	3.60	3.40	2.00

Self contained luminaires Wide area illumination

Distance table for plane emergency routes / distance data in meters

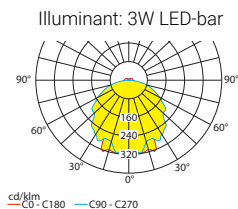

Luminous flux emergency / mains: 190lm/380lm – **Rated operating time: 8h**

h	2.00	2.50	3.00	3.50	4.00	4.50	5.00	5.50	6.00	6.50
a	7.90	8.60	9.00	9.50	9.70	9.50	9.50	9.70	9.60	9.40
b	3.10	3.40	3.40	3.40	3.40	3.40	3.20	2.90	1.90	1.50
c	5.50	5.90	5.80	5.40	5.10	5.20	5.40	5.60	5.80	6.00
d	2.10	1.90	1.80	1.90	2.00	2.10	2.30	2.40	2.50	1.80

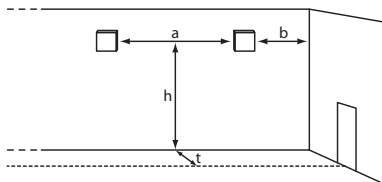

Wall mounting

Luminaires for central battery systems Wide area illumination

Distance table for plane emergency routes / distance data in meters

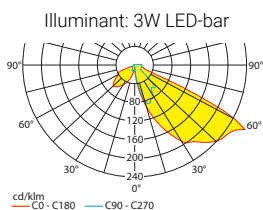

Luminous flux emergency / mains: 380lm

t = 1.00	h	2.00	2.50	3.00	3.50	4.00
	a	7.50	7.50	7.50	7.00	6.50
	b	3.00	3.00	3.00	2.50	2.00
t = 2.00	h	2.00	2.50	3.00	3.50	4.00
	a	8.50	9.00	9.00	9.00	8.50
	b	3.00	3.50	3.50	3.50	3.00
t = 3.00	h	2.00	2.50	3.00	3.50	4.00
	a	7.50	8.50	9.00	9.50	9.50
	b	3.00	3.50	3.50	3.50	3.00

Self contained luminaires Wide area illumination

Distance table for plane emergency routes / distance data in meters

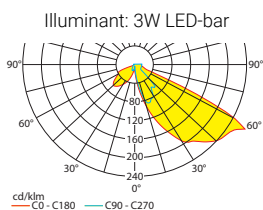

Luminous flux emergency / mains: 380lm/380lm – **Rated operating time: 1h**

t = 1.00	h	2.00	2.50	3.00	3.50	4.00
	a	7.50	7.50	7.50	7.00	6.50
	b	3.00	3.00	3.00	2.50	2.00
t = 2.00	h	2.00	2.50	3.00	3.50	4.00
	a	8.50	9.00	9.00	9.00	8.50
	b	3.00	3.50	3.50	3.50	3.00
t = 3.00	h	2.00	2.50	3.00	3.50	4.00
	a	7.50	8.50	9.00	9.50	9.50
	b	3.00	3.50	3.50	3.50	3.00

Self contained luminaires Wide area illumination

Distance table for plane emergency routes / distance data in meters

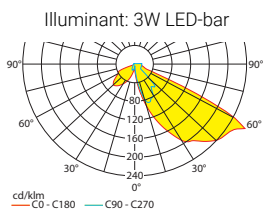

Luminous flux emergency / mains: 380lm/380lm – **Rated operating time: 3h**

t = 1.00	h	2.00	2.50	3.00	3.50	4.00
	a	7.50	7.50	7.50	7.00	6.50
	b	3.00	3.00	3.00	2.50	2.00
t = 2.00	h	2.00	2.50	3.00	3.50	4.00
	a	8.50	9.00	9.00	9.00	8.50
	b	3.00	3.50	3.50	3.50	3.00
t = 3.00	h	2.00	2.50	3.00	3.50	4.00
	a	7.50	8.50	9.00	9.50	9.50
	b	3.00	3.50	3.50	3.50	3.00

Self contained luminaires Wide area illumination

Distance table for plane emergency routes / distance data in meters

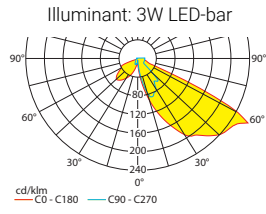

Luminous flux emergency / mains: 190lm/380lm – **Rated operating time: 8h**

t = 1.00	h	2.00	2.50	3.00	3.50	4.00
	a	6.00	5.50	5.50	5.00	4.00
	b	2.50	2.00	2.00	1.50	0.50
t = 2.00	h	2.00	2.50	3.00	3.50	4.00
	a	6.50	6.50	6.50	6.50	6.00
	b	2.50	2.50	2.50	2.00	1.50
t = 3.00	h	2.00	2.50	3.00	3.50	4.00
	a	5.50	6.00	6.50	6.00	6.00
	b	2.00	2.00	2.00	1.50	1.50