



# INTEGRA UNILINE BEL

## Safety luminaire in compliance with EN 60598-1/2-22 and EN 1838.

Slim and screwless safety luminaire for area illumination for mounting in approved trunking light gear trays. The luminaire can be rotated around its own axis in 30° or 45° increments using the built-in locking mechanism. For an additional charge, the luminaire can be supplied factory-fitted in trunking light gear trays purchased and machined by us (see table below for details). The luminaire is available with 3 W, 6 W and 10 W LED-bar. The 3 W version can be converted to a combined escape sign safety luminaire with either 23 m or 30 m recognition distance in just a few seconds using an optional set. A pictogram set is included with the optional pictogram disk (not possible for 8-hour self contained luminaires).

**ATTENTION!** The specified protection class refers to the luminaire (room side) when installed. **If installed in a gear tray with a different protection class, the lower protection class applies.**

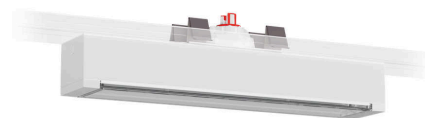

Figure shows accessory

## Technical specifications

Luminaire type	Luminaires for central battery systems			Self contained luminaires
	3 W LED-bar	6 W LED-bar	10 W LED-bar	3 W LED-bar
Illuminant	3 W LED-bar	6 W LED-bar	10 W LED-bar	3 W LED-bar
Colour	white			
Material	Polycarbonate (light cover clear)			
Mounting type	Trunking light mounting			
Dimensions (W x H x D)	336 x 54 x 59 mm			
Dimensions Trunking system intake (W x H x D)	min. 120 x 39 x 38 mm / max. 120 x 39 x 72.5 mm			
Protection class	IP54			
Safety class	see gear tray			
IK Safety class	IK03			
Light current (mains)	380 lm	600 lm	1050 lm	380 lm
Light current (emergency)				
Rated operating time 1h	-	-	-	380 lm
Rated operating time 3h	-	-	-	320 lm
Rated operating time 8h	-	-	-	140 lm
Luminous flux				
Emergency (DC) / mains				
Rated operating time 1h	-	-	-	100% / 100%
Rated operating time 3h	-	-	-	85% / 100%
Rated operating time 8h	-	-	-	40% / 100%
Power consumption	6 VA	10.3 VA	15 VA	6 VA
Battery current input	19 mA	27 mA	41 mA	-
Battery duration				
Battery operation				1h / 3h / 8h
Voltage supply	230V 50/60Hz; 220V DC +25/-20%			230V 50/60Hz
NiMH-battery				
Rated operating time 1h	-	-	-	4,8V 2,0Ah
Rated operating time 3h	-	-	-	4,8V 2,0Ah
Rated operating time 8h	-	-	-	4,8V 2,0Ah
Temperature range	-10°C to +40°C			-
Non-maintained mode				0°C to +35°C
Maintained mode				-5°C to +30°C
optional				
Multi-switch and monitoring module	DALI ELC MSÜ3 SET009 SET010			-
Self monitoring				SELF CHECK
Central monitoring				SAFELOG Line
Wireless monitoring				SAFELOG Wireless

## Accessories

Pictogram disc set - UNILINE

## Trunking light mounting

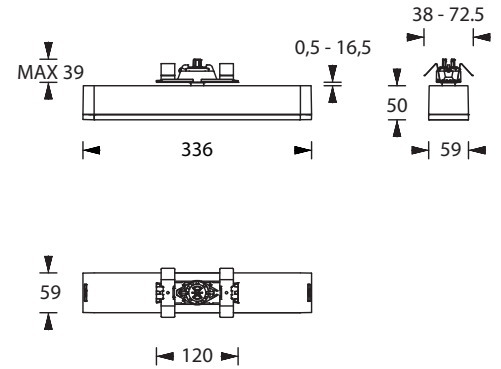

## Use for trunking light systems

The product is currently tested and approved for use in the following trunking light systems:

Manufacturer	Type	Minimum length	Manufacturer Art. No.	Quantity of poles	Remarks
TRILUX	E-LINE NEXT	737 mm	(8337500)	5	compatible and available ex works
SITECO	LICROSS	500 mm	(56TL1M 0-B)	6	compatible and available ex works
SITECO	MODARIO	897 mm	(5TR305SEMDB)	8	compatible and available ex works
RIDI	LINIA	489 mm	(1500153)	11	compatible and available ex works
REGENT	TRAQ	590 mm	(1021.7449)	7	compatible and available ex works

The specified trunking light gear trays have the required minimum length. Longer gear trays are possible if the current collector is positioned accordingly. The product can also be ordered fully assembled and tested (delivery time approx. 4 weeks), please refer to the picture price list for the additional costs.

## Lighting data and tables of luminaire distances ( $E = 1,25 \text{ lx}$ )

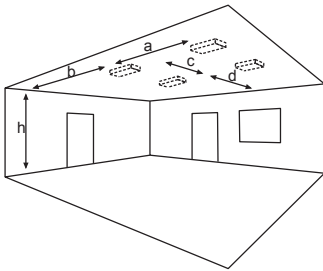

Ceiling mounting

### Luminaires for central battery systems Wide area illumination

Distance table for plane emergency routes / distance data in meters

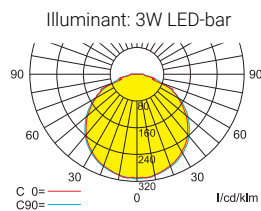

Luminous flux emergency / mains: 380lm

	h	a	b	c	d	2.50	3.00	3.50	4.00	4.50	5.00	5.50	6.00	6.50	7.00	7.50	8.00	8.50	9.00	9.50	
h	2.50	3.00	3.50	4.00	4.50	5.00	5.50	6.00	6.50	7.00	7.50	8.00	8.50	9.00	9.50						
a	10.10	10.90	11.60	12.10	12.50	12.90	13.10	13.30	13.50	13.50	13.50	13.40	13.20	12.90	12.50						
b	4.10	4.30	4.50	4.60	4.70	4.70	4.70	4.60	4.50	4.30	4.00	3.60	3.10	2.40	1.30						
c	10.10	10.90	11.60	12.10	12.50	12.90	13.10	13.30	13.50	13.50	13.50	13.40	13.20	12.90	12.50						
d	4.10	4.30	4.50	4.60	4.70	4.70	4.70	4.60	4.50	4.30	4.00	3.60	3.10	2.40	1.30						

### Luminaires for central battery systems Wide area illumination

Distance table for plane emergency routes / distance data in meters

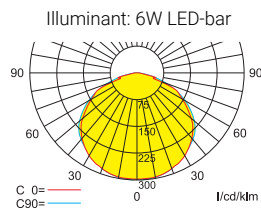

Luminous flux emergency / mains: 600lm

	h	a	b	c	d	2.00	3.00	4.00	5.00	6.00	7.00	8.00	9.00	10.00	11.00
h	2.00	3.00	4.00	5.00	6.00	7.00	8.00	9.00	10.00	11.00					
a	10.20	12.60	14.00	15.10	15.90	16.40	16.80	16.70	16.50	15.90					
b	4.30	5.00	5.50	5.80	5.90	5.80	5.50	5.00	4.10	2.70					
c	10.20	12.60	14.00	15.10	15.90	16.40	16.80	16.70	16.50	15.90					
d	4.30	5.00	5.50	5.80	5.90	5.80	5.50	5.00	4.10	2.70					

**Luminaires for central battery systems Wide area illumination**

**Distance table for plane emergency routes / distance data in meters**

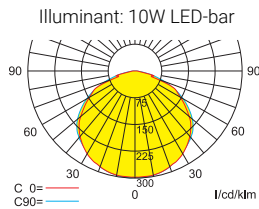

Luminous flux emergency / mains: 1050lm

h	2.00	3.00	4.00	5.00	6.00	7.00	8.00	9.00	10.00	11.00	12.00	13.00	14.00	15.00
a	10.40	14.60	16.80	18.10	19.30	20.30	21.00	21.60	22.10	22.20	22.10	21.90	21.40	20.70
b	4.50	6.00	6.70	7.20	7.50	7.80	7.80	7.70	7.50	7.10	6.50	5.70	4.50	2.50
c	10.40	14.60	16.80	18.10	19.30	20.30	21.00	21.60	22.10	22.20	22.10	21.90	21.40	20.70
d	4.50	6.00	6.70	7.20	7.50	7.80	7.80	7.70	7.50	7.10	6.50	5.70	4.50	2.50

**Self contained luminaires Wide area illumination**

**Distance table for plane emergency routes / distance data in meters**

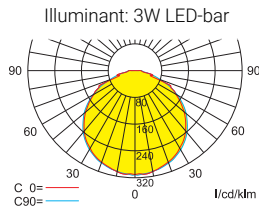

Luminous flux emergency / mains: 380lm/380lm – **Rated operating time: 1h**

h	2.50	3.00	3.50	4.00	4.50	5.00	5.50	6.00	6.50	7.00	7.50	8.00	8.50	9.00	9.50
a	10.10	10.90	11.60	12.10	12.50	12.90	13.10	13.30	13.50	13.50	13.50	13.40	13.20	12.90	12.50
b	4.10	4.30	4.50	4.60	4.70	4.70	4.70	4.60	4.50	4.30	4.00	3.60	3.10	2.40	1.30
c	10.10	10.90	11.60	12.10	12.50	12.90	13.10	13.30	13.50	13.50	13.50	13.40	13.20	12.90	12.50
d	4.10	4.30	4.50	4.60	4.70	4.70	4.70	4.60	4.50	4.30	4.00	3.60	3.10	2.40	1.30

**Self contained luminaires Wide area illumination**

**Distance table for plane emergency routes / distance data in meters**

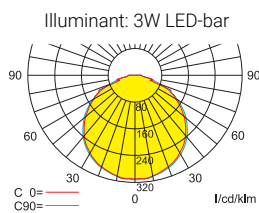

Luminous flux emergency / mains: 320lm/380lm – **Rated operating time: 3h**

h	2.50	3.00	3.50	4.00	4.50	5.00	5.50	6.00	6.50	7.00	7.50	8.00	8.50
a	9.60	10.40	10.90	11.40	11.70	12.00	12.20	12.40	12.40	12.30	12.20	12.00	11.70
b	3.80	4.10	4.20	4.30	4.30	4.30	4.30	4.10	3.90	3.60	3.20	2.60	1.80
c	9.60	10.40	10.90	11.40	11.70	12.00	12.20	12.40	12.40	12.30	12.20	12.00	11.70
d	3.80	4.10	4.20	4.30	4.30	4.30	4.30	4.10	3.90	3.60	3.20	2.60	1.80

**Self contained luminaires Wide area illumination**

**Distance table for plane emergency routes / distance data in meters**

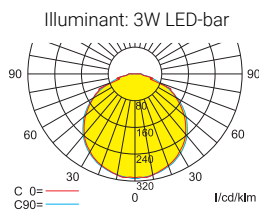

Luminous flux emergency / mains: 140lm/380lm – **Rated operating time: 8h**

h	2.50	3.00	3.50	4.00	4.50	5.00	5.50
a	7.40	7.80	8.00	8.20	8.20	8.10	7.80
b	2.80	2.90	2.80	2.70	2.40	2.00	1.40
c	7.40	7.80	8.00	8.20	8.20	8.10	7.80
d	2.80	2.90	2.80	2.70	2.40	2.00	1.40