



SMARTLUX 300 BEL-R DM

Safety luminaire in compliance with EN 60598-1/2-22 and EN 1838.

Appealing, modern IP54 safety luminaire with optics for escape route illumination, made of white polycarbonate and clear cover. Easy to install due to screwless click system.

Available with 3 Watt, 6 Watt or 10 Watt LED-bar.
Self contained luminaire 8h available on request.

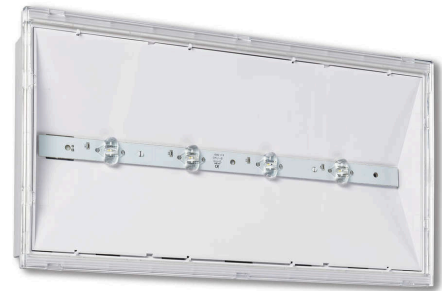

Technical specifications

Luminaire type	Luminaires for central battery systems			Self contained luminaires
	3 W LED-bar	6 W LED-bar	10 W LED-bar	3 W LED-bar
illuminant				
Connecting terminals	2 x 2.5 mm ² for double assignment			
Colour	white			
Material	Polycarbonate (light cover clear)			
Mounting type	Ceiling mounting			
Additional mounting types*	Recessed mounting, Ceiling mounting (wire suspension), Pendulum mounting			
Dimensions (W x H x D)	DM 313 x 174 x 54 mm			
Protection class	IP54			
Safety class	II			
IK Safety class	IK03			
Light current (mains)	350 lm	600 lm	1050 lm	350 lm
Light current (emergency)				
Rated operating time 1h	-	-	-	350 lm
Rated operating time 3h	-	-	-	350 lm
Luminous flux				
Emergency (DC) / mains				
Rated operating time 1h	-	-	-	100% / 100%
Rated operating time 3h	-	-	-	100% / 100%
Power consumption	6 VA	10.3 VA	15 VA	6 VA
Battery current input	19 mA	27 mA	41 mA	-
Battery duration				
Battery operation		-		1h / 3h
Voltage supply	230V 50/60Hz; 220V DC +25/-20%			230V 50/60Hz
NiMH-battery				
Rated operating time 1h	-	-	-	4,8V 2,0Ah
Rated operating time 3h	-	-	-	4,8V 4,2Ah
Temperature range	-10°C to +40°C			-
Non-maintained mode				0°C to +35°C
Maintained mode				-5°C to +30°C
optional				
Multi-switch and monitoring module	DALI ELC MSÜ3 SET009 SET010			-
Self monitoring				SELF CHECK
Central monitoring				SAFELOG Line
Wireless monitoring				SAFELOG Wireless

* Optional accessory required

Accessories

Ball protection cover
Wire guard
Recessed frame - set
Universal cover plate
Central pendulum - Plastic
Cable assembly set

Ceiling mounting

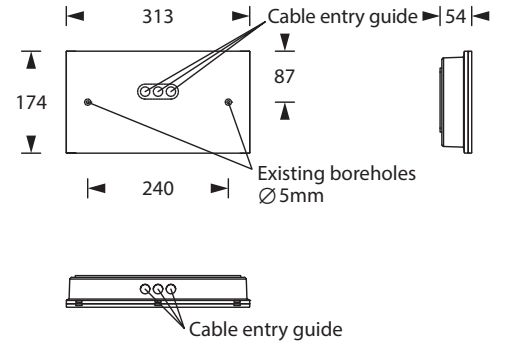

Lighting data and tables of luminaire distances (E = 1,25 lx)

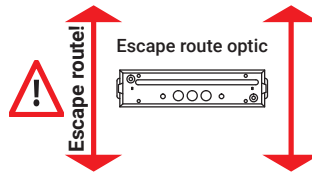
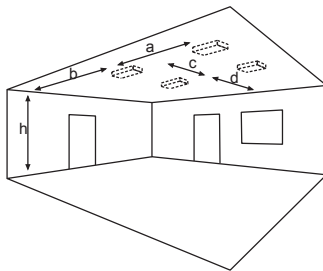

Ceiling mounting

Mounting direction

Luminaires for central battery systems **escape route optics**

Distance table for plane emergency routes / distance data in meters

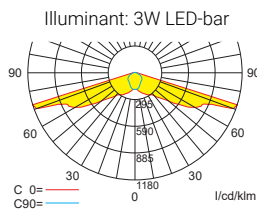

Luminous flux emergency / mains: 350lm

h	2.50	3.00	3.50	4.00	4.50	5.00	5.50	6.00	6.50	7.00	7.50	8.00	8.50	9.00	9.50
a	-	-	-	-	-	-	-	-	-	-	-	-	-	-	-
b	-	-	-	-	-	-	-	-	-	-	-	-	-	-	-
c	16.30	19.60	21.50	24.60	25.20	26.40	26.20	25.00	25.00	25.00	24.00	21.50	15.60	13.10	9.30
d	7.60	9.20	9.60	8.90	8.80	9.00	8.80	8.00	5.70	4.50	3.00	3.00	2.90	2.90	2.50

Luminaires for central battery systems **escape route optics**

Distance table for plane emergency routes / distance data in meters

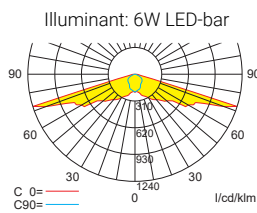

Luminous flux emergency / mains: 600lm

h	2.50	3.00	3.50	4.00	4.50	5.00	5.50	6.00	6.50	7.00	7.50	8.00	8.50	9.00	10.00	11.00	12.00	13.00
a	-	-	-	-	-	-	-	-	-	-	-	-	-	-	-	-	-	-
b	-	-	-	-	-	-	-	-	-	-	-	-	-	-	-	-	-	-
c	18.10	21.20	24.10	26.80	29.40	30.80	31.80	32.80	34.00	32.40	31.30	31.60	31.70	30.20	29.70	23.50	16.70	10.80
d	8.50	9.90	11.10	12.30	12.20	11.30	11.10	11.20	11.00	9.50	9.10	8.70	7.90	7.20	6.40	5.00	5.00	1.60

Luminaires for central battery systems **escape route optics**

Distance table for plane emergency routes / distance data in meters

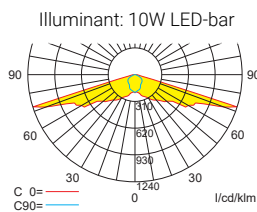

Luminous flux emergency / mains: 1050lm

h	2.00	3.00	4.00	5.00	6.00	7.00	8.00	9.00	10.00	11.00	12.00	13.00	14.00	15.00	16.00	17.00	18.00
a	-	-	-	-	-	-	-	-	-	-	-	-	-	-	-	-	-
b	-	-	-	-	-	-	-	-	-	-	-	-	-	-	-	-	-
c	15.50	22.00	28.20	33.90	39.20	41.50	43.50	44.00	41.50	41.90	39.90	39.20	35.00	27.00	19.50	15.20	11.90
d	7.30	10.40	13.20	15.60	16.10	14.60	14.80	14.20	11.90	10.80	9.40	9.00	8.00	6.00	4.00	2.00	1.40

Self contained luminaires **escape route optics**

Distance table for plane emergency routes / distance data in meters

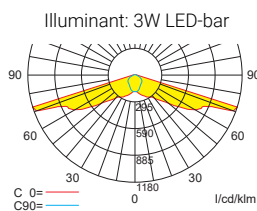

Luminous flux emergency / mains: 350lm/350lm - **Rated operating time: 1h**

h	2.50	3.00	3.50	4.00	4.50	5.00	5.50	6.00	6.50	7.00	7.50	8.00	8.50	9.00	9.50
a	-	-	-	-	-	-	-	-	-	-	-	-	-	-	-
b	-	-	-	-	-	-	-	-	-	-	-	-	-	-	-
c	16.30	19.60	21.50	24.60	25.20	26.40	26.20	25.00	25.00	25.00	24.00	21.50	15.60	13.10	9.30
d	7.60	9.20	9.60	8.90	8.80	9.00	8.80	8.00	5.70	4.50	3.00	3.00	2.90	2.90	2.50

Self contained luminaires escape route optics

Distance table for plane emergency routes / distance data in meters

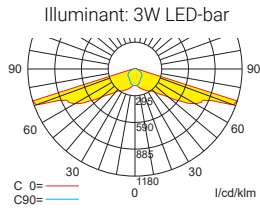

Luminous flux emergency / mains: 350lm/350lm – **Rated operating time: 3h**

h	2.50	3.00	3.50	4.00	4.50	5.00	5.50	6.00	6.50	7.00	7.50	8.00	8.50	9.00	9.50
a	-	-	-	-	-	-	-	-	-	-	-	-	-	-	-
b	-	-	-	-	-	-	-	-	-	-	-	-	-	-	-
c	16.30	19.60	21.50	24.60	25.20	26.40	26.20	25.00	25.00	25.00	24.00	21.50	15.60	13.10	9.30
d	7.60	9.20	9.60	8.90	8.80	9.00	8.80	8.00	5.70	4.50	3.00	3.00	2.90	2.90	2.50